



LEADFRAME MOUNTED SEVEN SEGMENT MONOLITHIC NUMERIC INDICATORS

5082-7400/7430 SERIES

SOLID STATE
DISPLAYS

Features

- **COMPACT PACKAGE SIZES**
.25" Package Width
.150" and .200" Digit Spacing
- **STROBED OPERATION**
Minimizes Lead Connections
- **FULLY ENCAPSULATED STANDARD DIP PACKAGES**
End Stackable
Integral Red Filter
Extremely Rugged Construction
- **I.C. COMPATIBLE**
- **CATEGORIZED FOR LUMINOUS INTENSITY**
Assures uniformity of light output from unit to unit within single category.

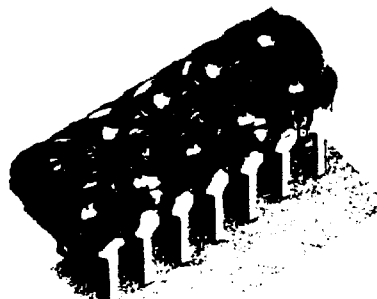

Description

The HP 5082-7400/-7430 series are 2.79 mm (.11"), seven segment GaAsP numeric indicators packaged in 2, 3, 4 and 5 digit clusters. An integral magnification technique increases the luminous intensity, thereby making low power consumption possible. Options include either the standard lower right hand decimal point or a centered decimal point.

Applications include mobile telephones, hand held calculators, portable instruments and many other products requiring compact, rugged, long lifetime active indicators.

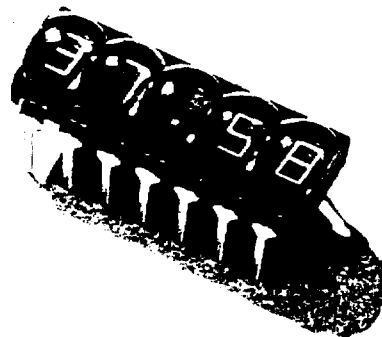

Device Selection Guide

| Digits per Cluster | Configuration | Inter-Digit Spacing mm (inches) | Part Number | |
|--------------------|---------------|------------------------------------|----------------------|---------------------|
| | Device | | Center Decimal Point | Right Decimal Point |
| 2 (right) | | 5.08 (.200) | | 5082-7432 |
| 3 | | 5.08 (.200) | | 5082-7433 |
| 4 | | 3.81 (.150) | 5082-7404 | 5082-7414 |
| 5 | | 3.81 (.150) | 5082-7405 | 5082-7415 |

Absolute Maximum Ratings

| Parameter | Symbol ¹ | Min. | Max. | Units |
|--|---------------------|------|------|-------|
| Peak Forward Current per Segment or dp (Duration < 500 μ s) 5082-7432/7433 | I _{PEAK} | | 50 | mA |
| Peak Forward Current per Segment or dp (Duration < 1 msec) 5082-7404/7405/7414/7415 | I _{PEAK} | | 110 | mA |
| Average Current per Segment or dp | I _{AVG} | | 5 | mA |
| Power Dissipation per Digit ¹ | P _D | | 80 | mW |
| Operating Temperature, Ambient | T _A | -40 | 75 | °C |
| Storage Temperature | T _S | -40 | 100 | °C |
| Reverse Voltage | V _R | | 5 | V |
| Solder Temperature 1/16" below seating plane (t \leq 3 sec) ² | | | 230 | °C |

- Notes: 1. Derate linearly @ 1 mW/°C above 25°C ambient.
2. See Mechanical section for recommended flux removal solvents.

Electrical/Optical Characteristics at T_A = 25°C

| Parameter | Symbol | Test Condition | Min. | Typ. | Max. | Units |
|--|---------------------------------|--|------|------|------|----------|
| Luminous Intensity/Segment or dp ^{3,4} 5082-7432/7433 | I _v | I _{AVG} = 500 μ A (I _{PK} = 5 mA duty cycle = 10%) | 10 | 40 | | μ cd |
| Luminous Intensity/Segment or dp ^{3,4} (Time Averaged) 5082-7404/7405/7414/7415 | I _v | I _{AVG} = 1 mA I _{PK} = 10 mA duty cycle = 10% | 5 | 20 | | μ cd |
| Peak Wavelength | λ _{PEAK} | | | 655 | | nm |
| Forward Voltage/Segment or dp 5082-7432/-7433 | V _F | I _F = 5 mA | | 1.55 | 2.0 | V |
| Forward Voltage/Segment or dp 5082-7404/7405/7414/7415 | V _F | I _F = 10 mA | | 1.55 | 2.0 | V |
| Reverse Voltage/Segment or dp | V _R | I _R = 200 μ A | 5 | | | V |
| Rise and Fall Time ⁵ | t _r , t _f | | | 10 | | ns |

NOTES:

- The digits are categorized for luminous intensity. Intensity categories are designated by a letter located on the back side of the package.
- Each character of the display is matched for luminous intensity at the test conditions shown. Operation of the display at lower peak currents may cause intensity mismatch within the display. Operation at peak currents less than 5.0 mA may cause objectionable display segment matching.
- Time for a 10%-90% change of light intensity for step change in current.

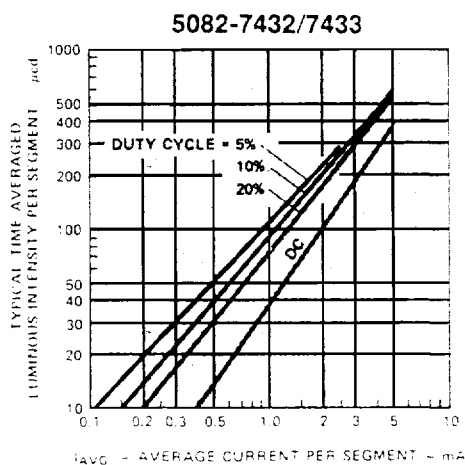

Figure 1. Typical Time Averaged Luminous Intensity per Segment (Digit Average) vs. Current per Segment.

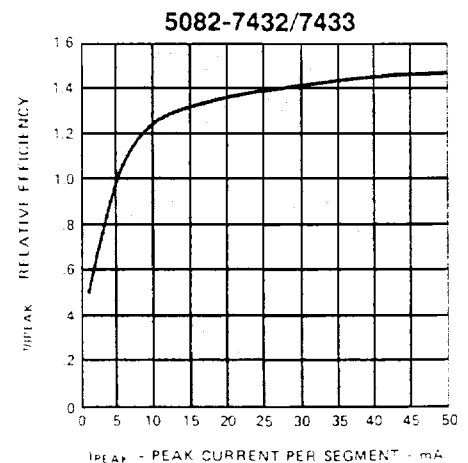

Figure 2. Relative Luminous Efficiency vs. Peak Current per Segment.

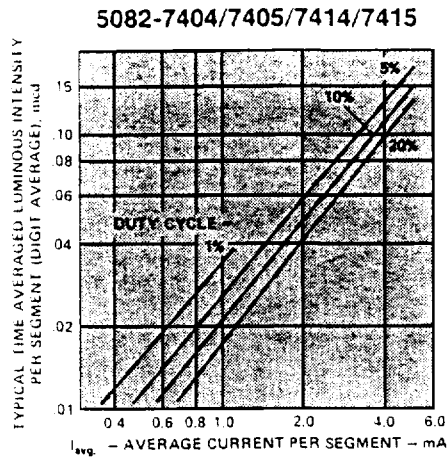

Figure 3. Typical Time Averaged Luminous Intensity per Segment (Digit Average) vs. Average Current per Segment.

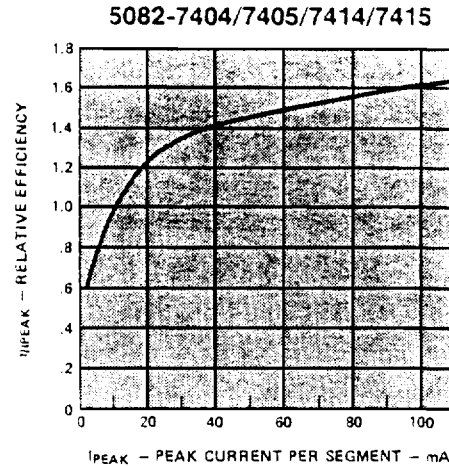

Figure 4. Relative Luminous Efficiency vs. Peak Current per Segment.

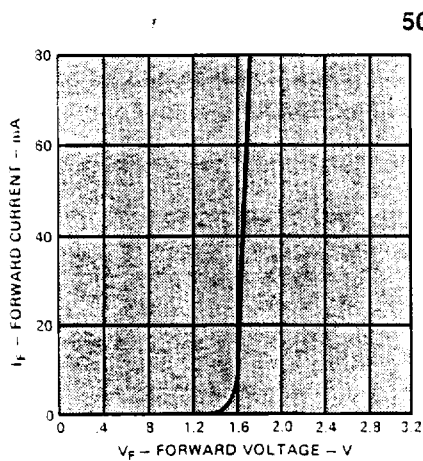

Figure 5. Forward Current vs. Forward Voltage.

5082-7400/7430 SERIES

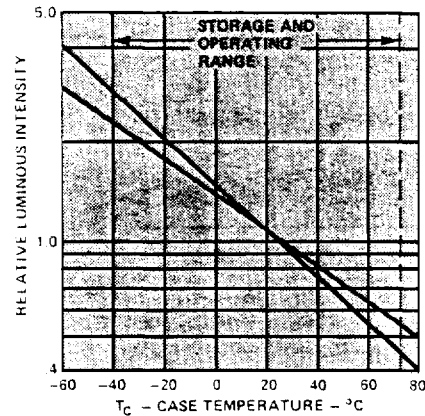

Figure 6. Relative Luminous Intensity vs. Case Temperature at Fixed Current Level.

Electrical/Optical

The 5082-7400/7430 series devices utilize a monolithic GaAsP chip of 8 common cathode segments for each display digit. The segment anodes of each digit are interconnected, forming an 8 by N line array, where N is the number of characters in the display. Each chip is positioned under an integrally molded lens giving a magnified character height of 2.79mm (0.11) inches. Satisfactory viewing will be realized within an angle of $\pm 30^\circ$ for the 7404/7405/7414/7415 and $\pm 20^\circ$ for the 7432/7433, measured from the center line of the digit.

The decimal point in the 7432, 7433, 7414, and 7415 displays is located at the lower right of the digit for conventional driving schemes.

The 5082-7404 and 7405 displays contain a centrally located decimal point which is activated in place of a digit. In long registers, this technique of setting off the decimal point significantly improves the display's readability. With respect to timing, the decimal point is treated as a separate character with its own unique time frame.

To improve display contrast, the plastic incorporates a red dye that absorbs strongly at all visible wavelengths except the 655 nm emitted by the LED. An additional filter, such as Plexiglass 2423, Panelgraphic 60 or 63, and SGL Homalite 100-1605, will further lower the ambient reflectance and improve display contrast.

Mechanical

The 5082-7400/7430 series package is a standard 12 or 14 Pin DIP consisting of a plastic encapsulated lead frame with integral molded lenses. It is designed for plugging into DIP sockets or soldering into PC boards. The lead frame construction allows use of standard DIP insertion tools and techniques. Alignment problems are simplified due to the clustering of digits in a single package. The shoulders of the lead frame pins are intentionally raised above the bottom of the package to allow tilt mounting of up to 20° from the PC board.

To optimize device optical performance, specially developed plastics are used which restrict the solvents that may be used for cleaning. It is recommended that only mixtures of Freon (F113) and alcohol be used for vapor cleaning processes, with an immersion time in the vapors of less than two (2) minutes maximum. Some suggested vapor cleaning solvents are Freon TE, Genesolv DI-15 or DE-15, Arklone A or K. A 60°C (140°C) water cleaning process may also be used, which includes a neutralizer rinse (3% ammonia solution or equivalent), a surfactant rinse (1% detergent solution or equivalent), a hot water rinse and a thorough air dry. Room temperature cleaning may be accomplished with Freon T-E35 or T-P35, Ethanol, Isopropanol or water with a mild detergent.

Package Description 5082-7404, -7405, -7414, -7415

Notes: 6. Dimensions in millimeters and (inches).
7. Tolerances on all dimension are $\pm .38$ mm ($\pm .015$ in.) unless otherwise noted.

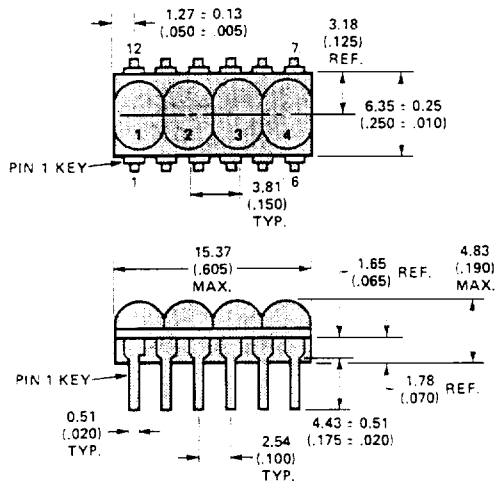

Figure 7. 5082-7404/7414

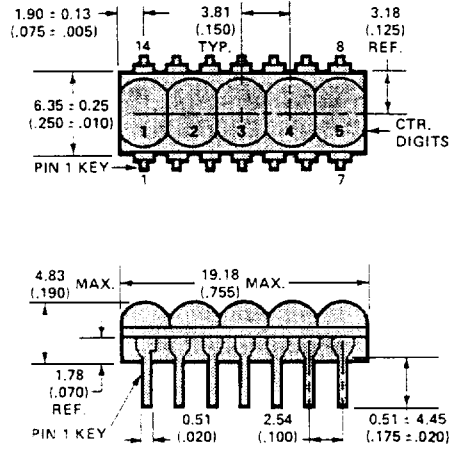

Figure 8. 5082-7405/7415.

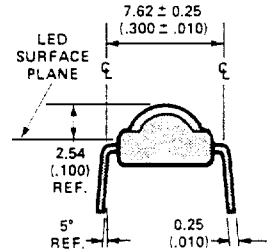

Figure 9. 5082-7404/7405/7414/7415

Magnified Character Font Description

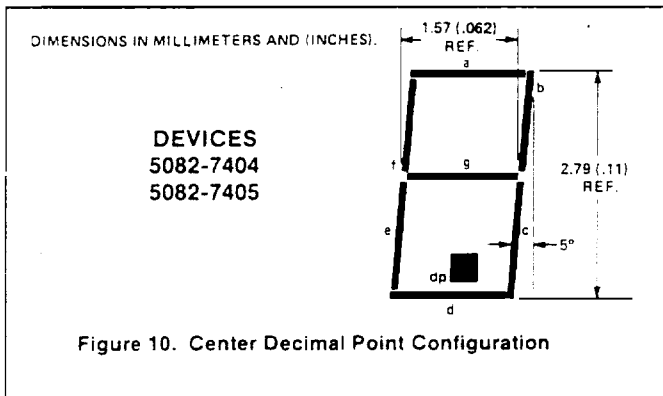

Figure 10. Center Decimal Point Configuration

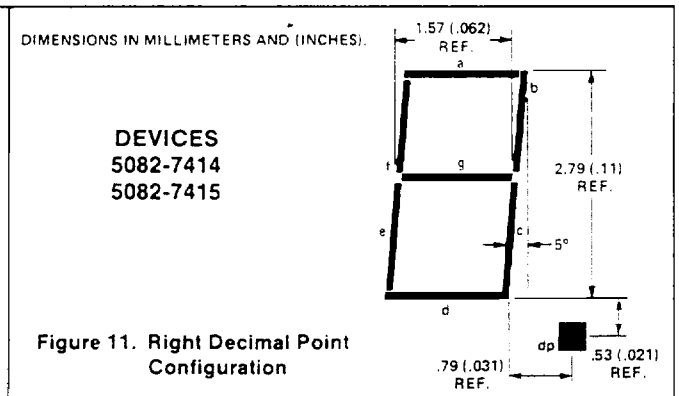

Figure 11. Right Decimal Point Configuration

Device Pin Description

| PIN NO. | 5082-7404/7414 FUNCTION | 5082-7405/7415 FUNCTION |
|---------|----------------------------|----------------------------|
| 1 | CATHODE 1 | CATHODE 1 |
| 2 | ANODE e | ANODE e |
| 3 | ANODE c | ANODE c |
| 4 | CATHODE 3 | CATHODE 3 |
| 5 | ANODE dp | ANODE dp |
| 6 | CATHODE 4 | ANODE d |
| 7 | ANODE g | CATHODE 5 |
| 8 | ANODE d | ANODE g |
| 9 | ANODE f | CATHODE 4 |
| 10 | CATHODE 2 | ANODE f |
| 11 | ANODE b | SEE NOTE 8 |
| 12 | ANODE a | ANODE b |
| 13 | — | CATHODE 2 |
| 14 | — | ANODE a |

Note 8: Leave Pin Unconnected.

Package Description 5082-7432, -7433

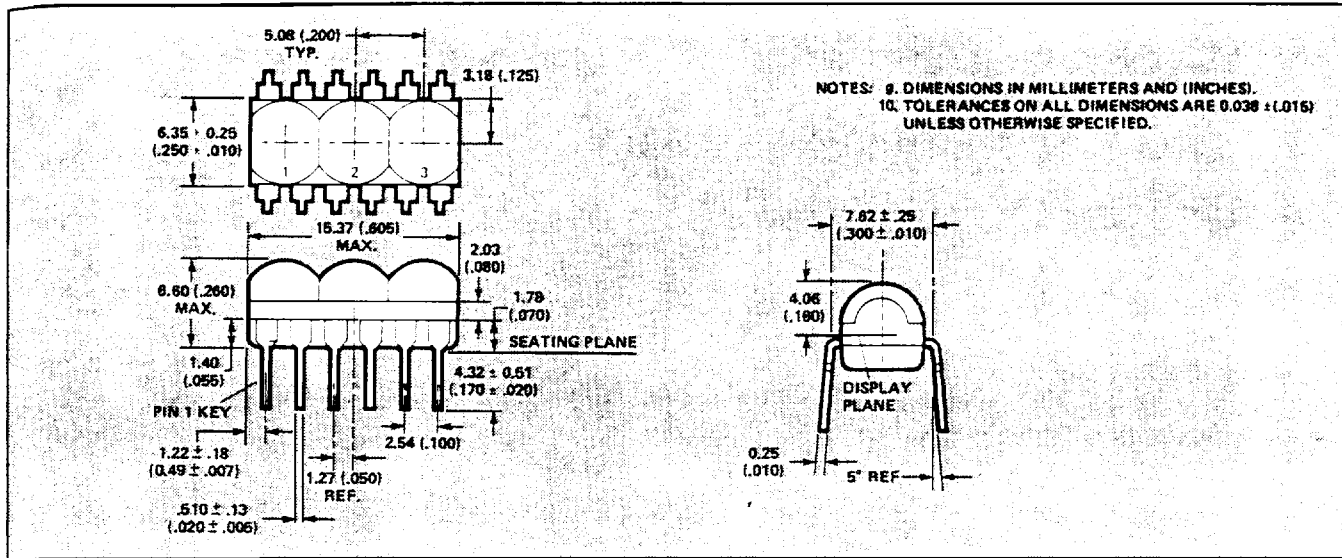

Figure 11.

Magnified Character Font Description

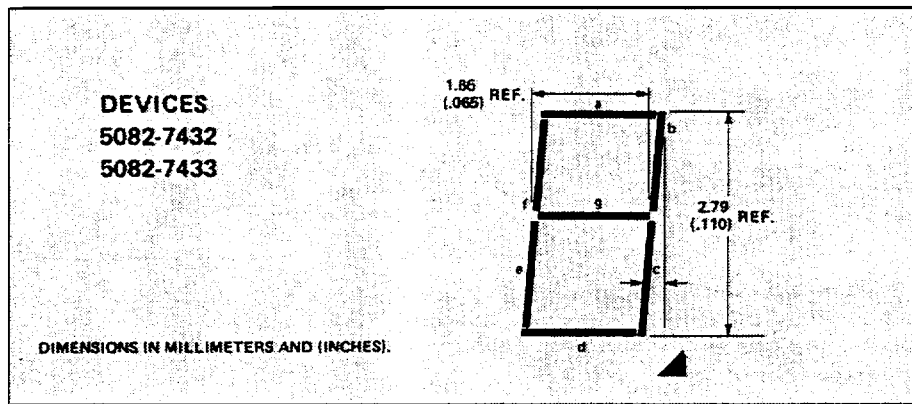

Figure 12.

Device Pin Description

| PIN NUMBER | 5082-7432 FUNCTION | 5082-7433 FUNCTION |
|------------|--------------------|--------------------|
| 1 | SEE NOTE 11. | CATHODE 1 |
| 2 | ANODE e | ANODE e |
| 3 | ANODE d | ANODE d |
| 4 | CATHODE 2 | CATHODE 2 |
| 5 | ANODE c | ANODE c |
| 6 | ANODE dp | ANODE dp |
| 7 | CATHODE 3 | CATHODE 3 |
| 8 | ANODE b | ANODE b |
| 9 | ANODE g | ANODE g |
| 10 | ANODE a | ANODE a |
| 11 | ANODE f | ANODE f |
| 12 | SEE NOTE 11. | SEE NOTE 11. |

NOTE 11. Leave Pin unconnected.